



System Requirements

Modus AM30 Single

(Transceiver)

- ① Builder provide single 25mm Conduit in floor chase from Power Supply to each Pedestal.
Detection zone is dependent on Tags/Labels to be used - refer to consultant.

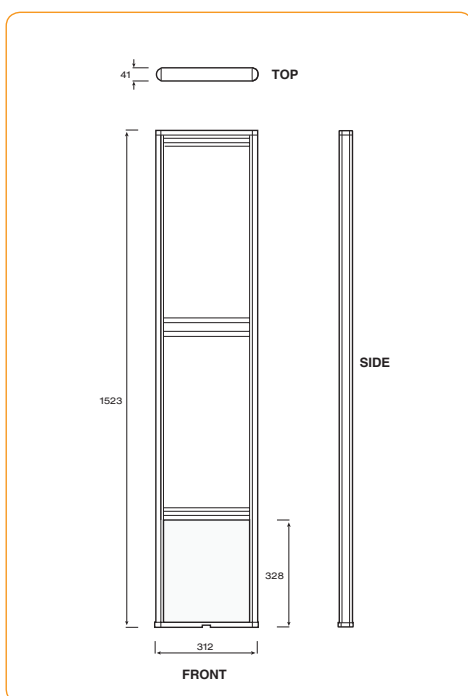
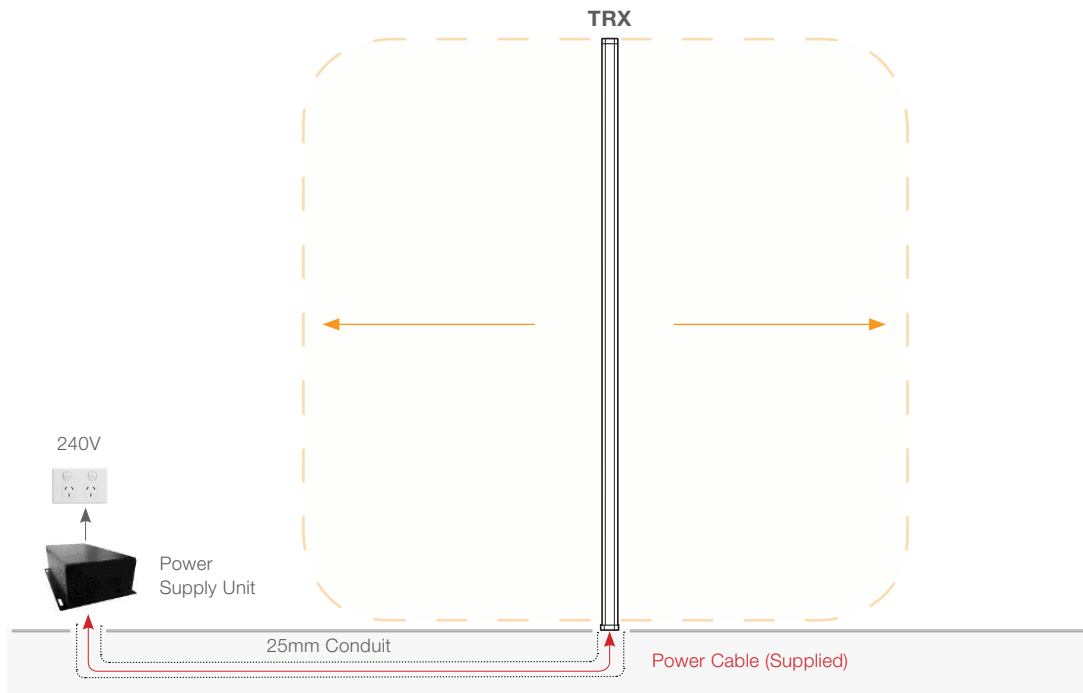

*Additional Pedestals may be added in same configuration

Modus AM30 Nuda transceiver-PSU:
CP2101-6423-5200

Power Supply:
210mm x 172mm x 70mm

Cable Spec

- **Power Cable:** 3 Core 7/0.30 Shielded Control Cable or equivalent.
- **Slave Cable:** Belden-M 8723 Multi-Conductor Shielded Twisted Pair Cable or equivalent.



System Requirements

Modus AM30 Dual

(Transceiver & Receiver)

① Builder provide single 25mm Conduit in floor chase from Power Supply to last Pedestal with T pieces and sweeps at centre of each Pedestal.

Pedestal spacing is dependent on Tags/Labels to be used - refer to consultant.

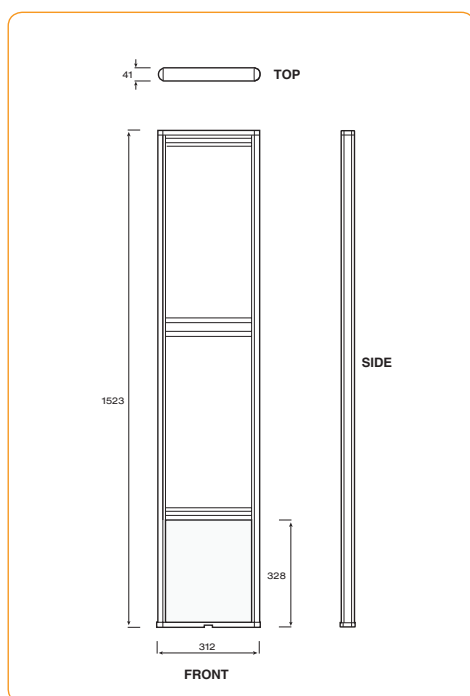
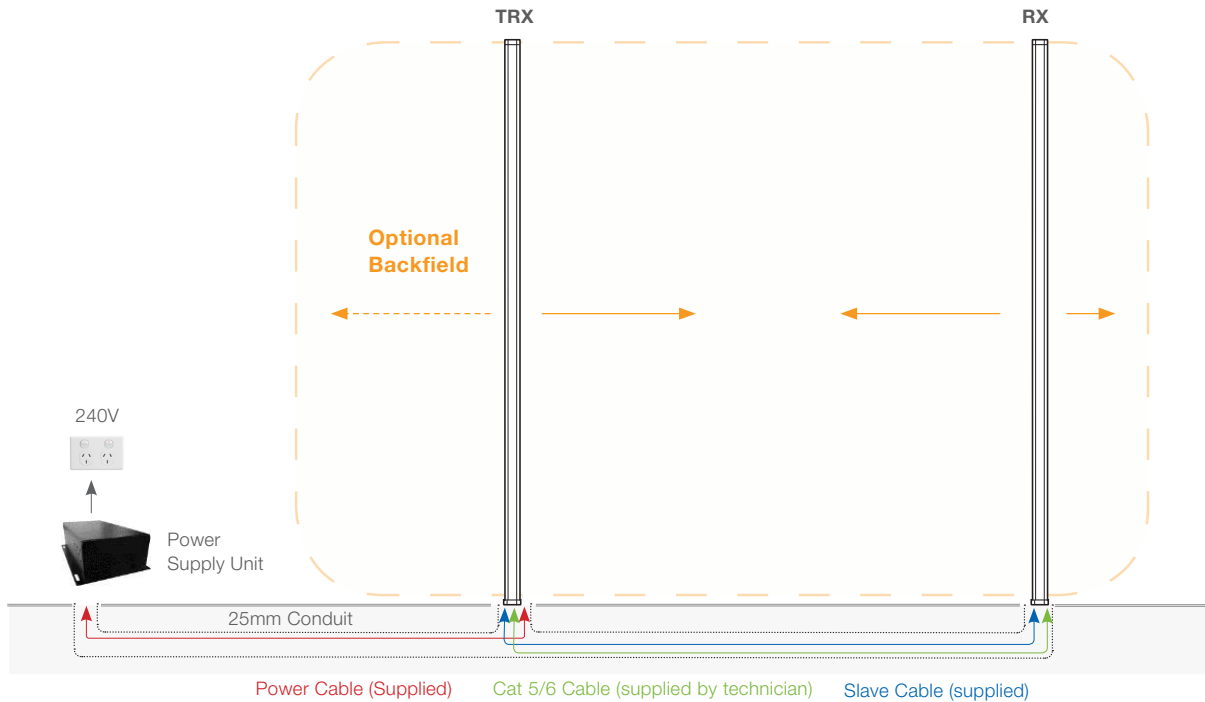

*Additional Pedestals may be added in same configuration

Modus AM30 Nuda transceiver-PSU:

CP2101-6423-5200

Modus AM30 Nuda receiver::

CP2101-6424-5200

Power Supply:

210mm x 172mm x 70mm

Cable Spec

- **Power Cable:** 3 Core 7/0.30 Shielded Control Cable or equivalent.
- **Slave Cable:** Belden-M 8723 Multi-Conductor Shielded Twisted Pair Cable or equivalent.



System Requirements

Modus AM30 Dual

(2x Transceiver)

- ① Builder provide single 25mm Conduit in floor chase from Power Supply to last Pedestal with T pieces and sweeps at centre of each Pedestal.

Pedestal spacing is dependent on Tags/Labels to be used - refer to consultant.

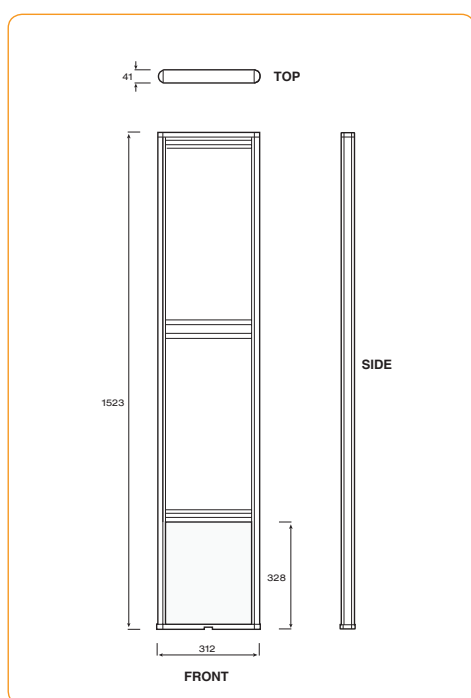
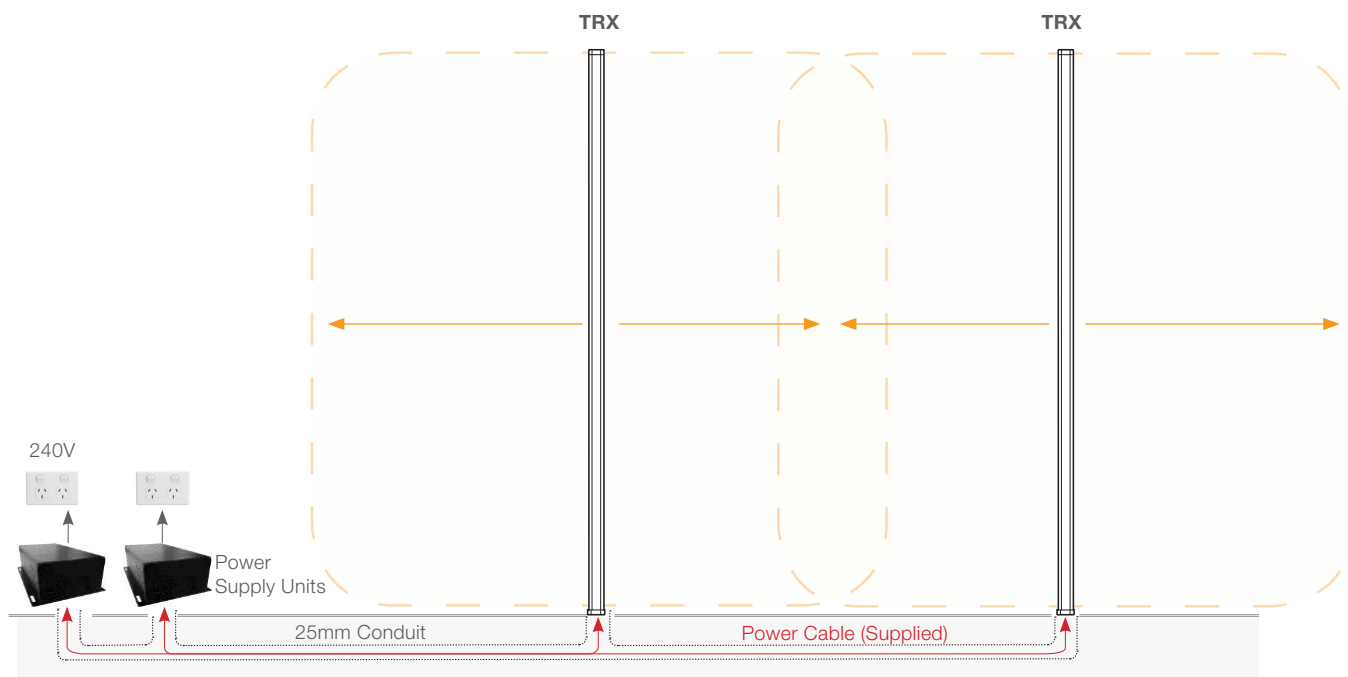

*Additional Pedestals may be added in same configuration

Modus AM30 Nuda transceiver-PSU:

CP2101-6423-5200

Power Supply:

210mm x 172mm x 70mm

Cable Spec

- **Power Cable:** 3 Core 7/0.30 Shielded Control Cable or equivalent.
- **Slave Cable:** Belden-M 8723 Multi-Conductor Shielded Twisted Pair Cable or equivalent.



System Requirements

Modus AM30 Dual

(2x Transceiver Separate)

- ① Builder provide single 25mm Conduit in floor chase from Power Supply to each Pedestal.
Pedestal spacing is dependent on Tags/Labels to be used - refer to consultant.

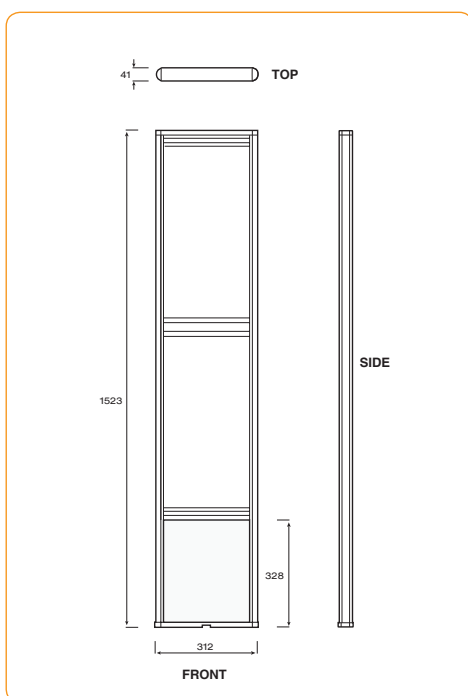
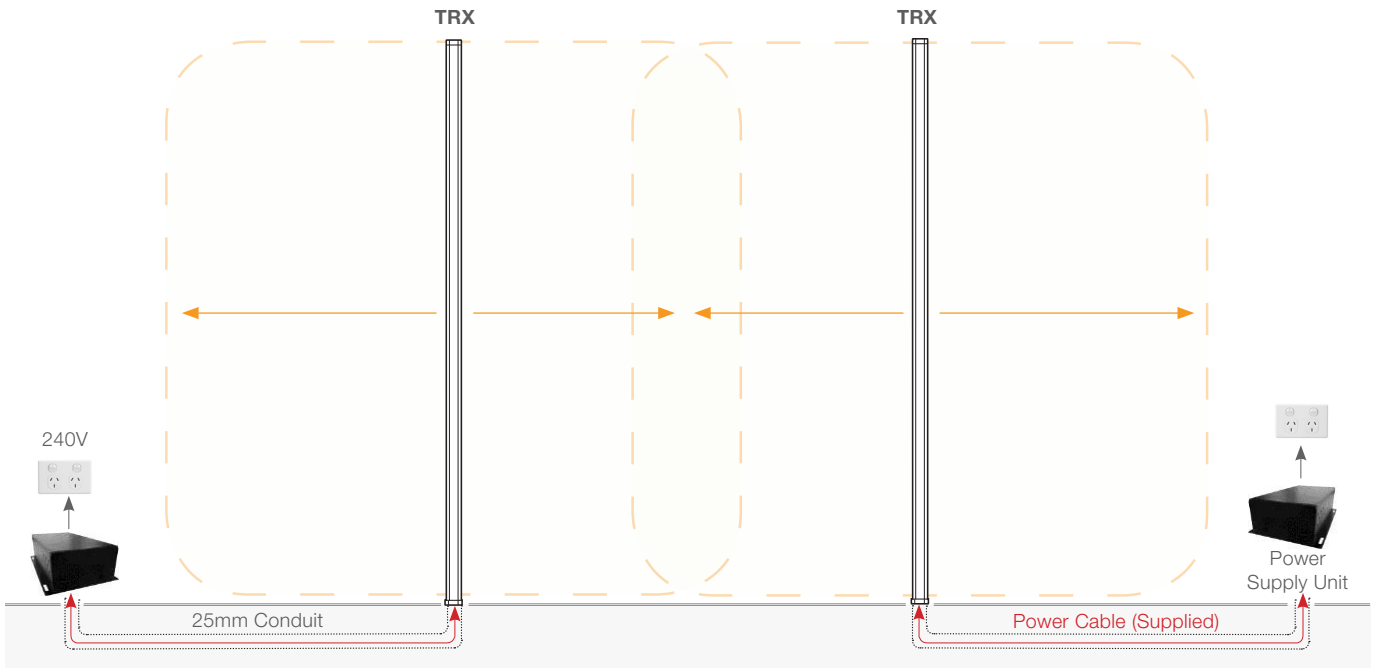

*Additional Pedestals may be added in same configuration

Modus AM30 Nuda transceiver-PSU:
CP2101-6423-5200

Power Supply:
210mm x 172mm x 70mm

Cable Spec

- **Power Cable:** 3 Core 7/0.30 Shielded Control Cable or equivalent.
- **Slave Cable:** Belden-M 8723 Multi-Conductor Shielded Twisted Pair Cable or equivalent.



System Requirements

Modus AM30 Triple

(Transceiver & 2x Receiver)

① Builder provide single 25mm Conduit in floor chase from Power Supply to last Pedestal with T pieces and sweeps at centre of each Pedestal.

Pedestal spacing is dependent on Tags/Labels to be used - refer to consultant.

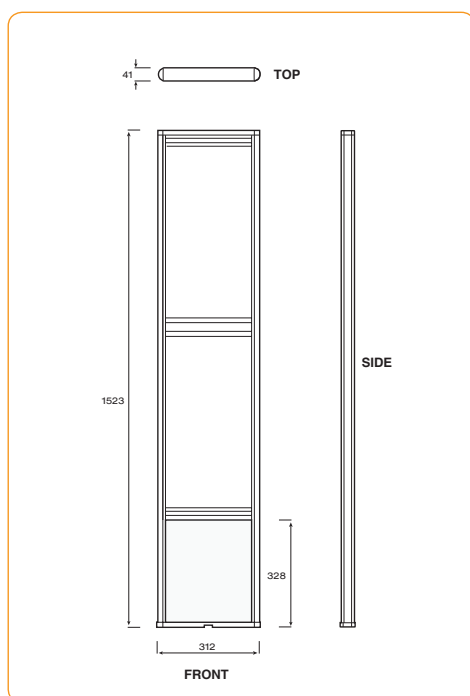
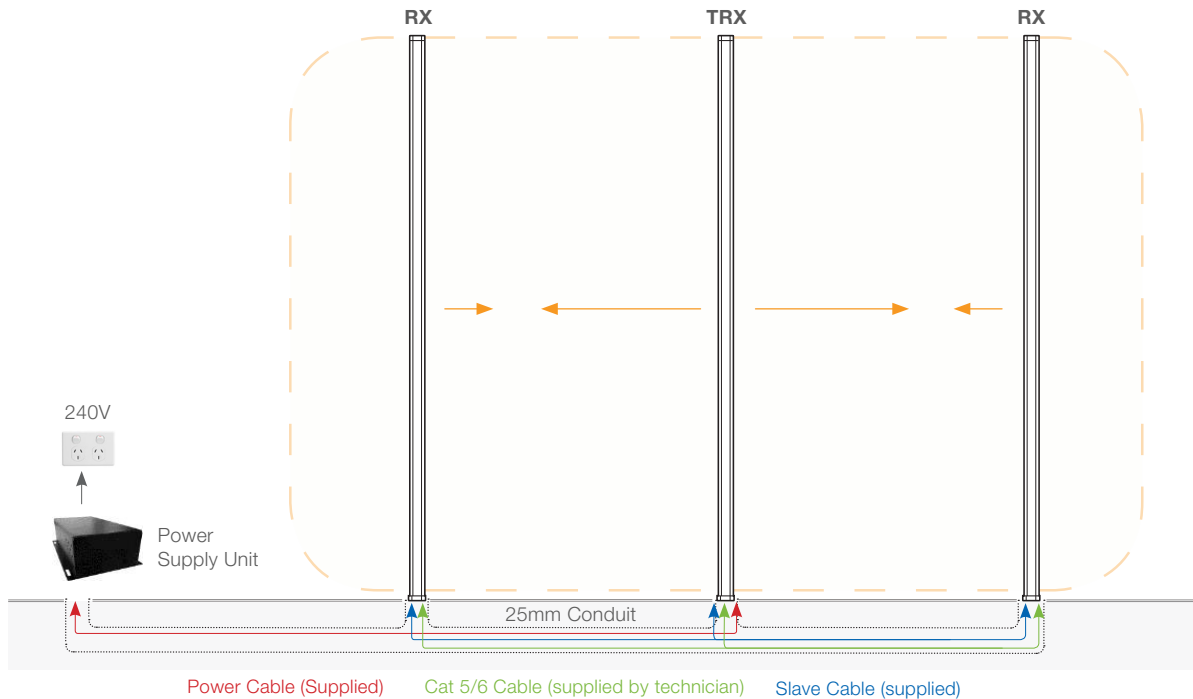

*Additional Pedestals may be added in same configuration

Modus AM30 Nuda transceiver-PSU:

CP2101-6423-5200

Modus AM30 Nuda receiver::

CP2101-6424-5200

Power Supply:

210mm x 172mm x 70mm

Cable Spec

- **Power Cable:** 3 Core 7/0.30 Shielded Control Cable or equivalent.
- **Slave Cable:** Belden-M 8723 Multi-Conductor Shielded Twisted Pair Cable or equivalent.



System Requirements

Modus AM30 Triple

(3X Transceiver)

① Builder provide single 25mm Conduit in floor chase from Power Supply to last Pedestal with T pieces and sweeps at centre of each Pedestal.

Pedestal spacing is dependent on Tags/Labels to be used - refer to consultant.

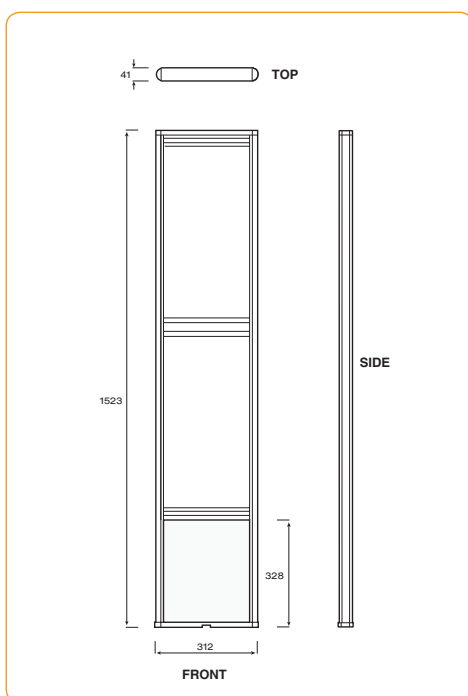
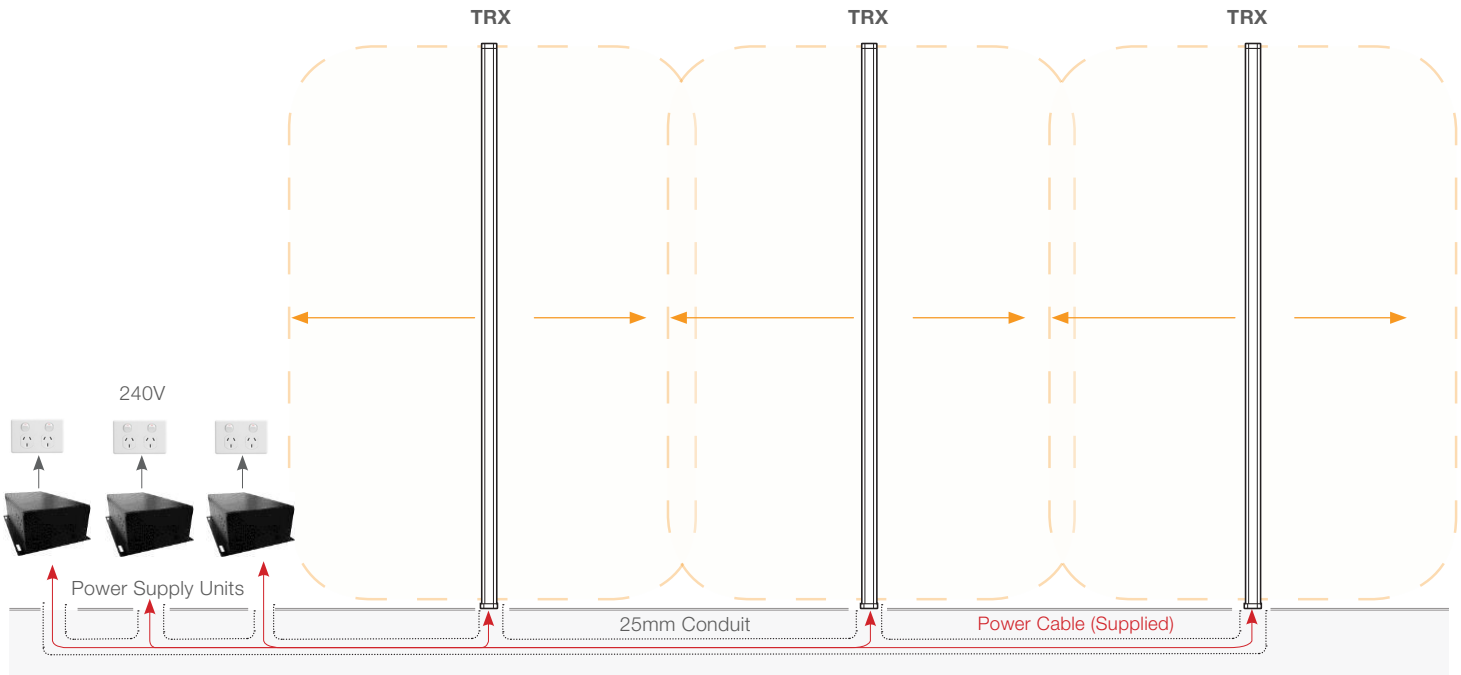

*Additional Pedestals may be added in same configuration

Modus AM30 Nuda transceiver-PSU:
CP2101-6423-5200

Power Supply:
210mm x 172mm x 70mm

Cable Spec

- **Power Cable:** 3 Core 7/0.30 Shielded Control Cable or equivalent.
- **Slave Cable:** Belden-M 8723 Multi-Conductor Shielded Twisted Pair Cable or equivalent.



System Requirements

Modus AM30 Quad

(2x Transceiver & 2x Receiver)

① Builder provide single 25mm Conduit in floor chase from Power Supply to last Pedestal with T pieces and sweeps at centre of each Pedestal.

Pedestal spacing is dependent on Tags/Labels to be used - refer to consultant.

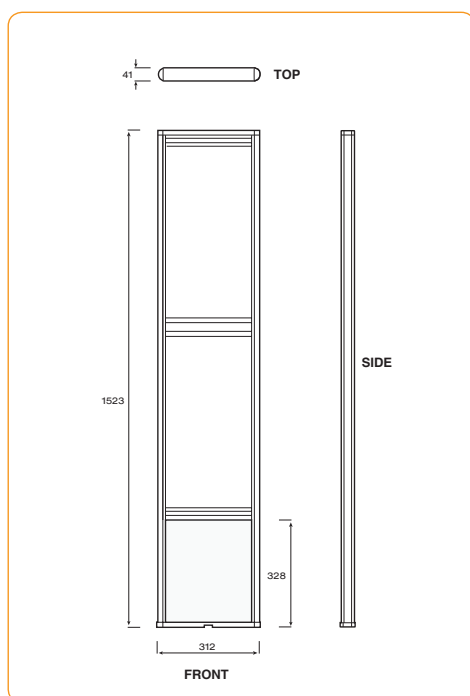
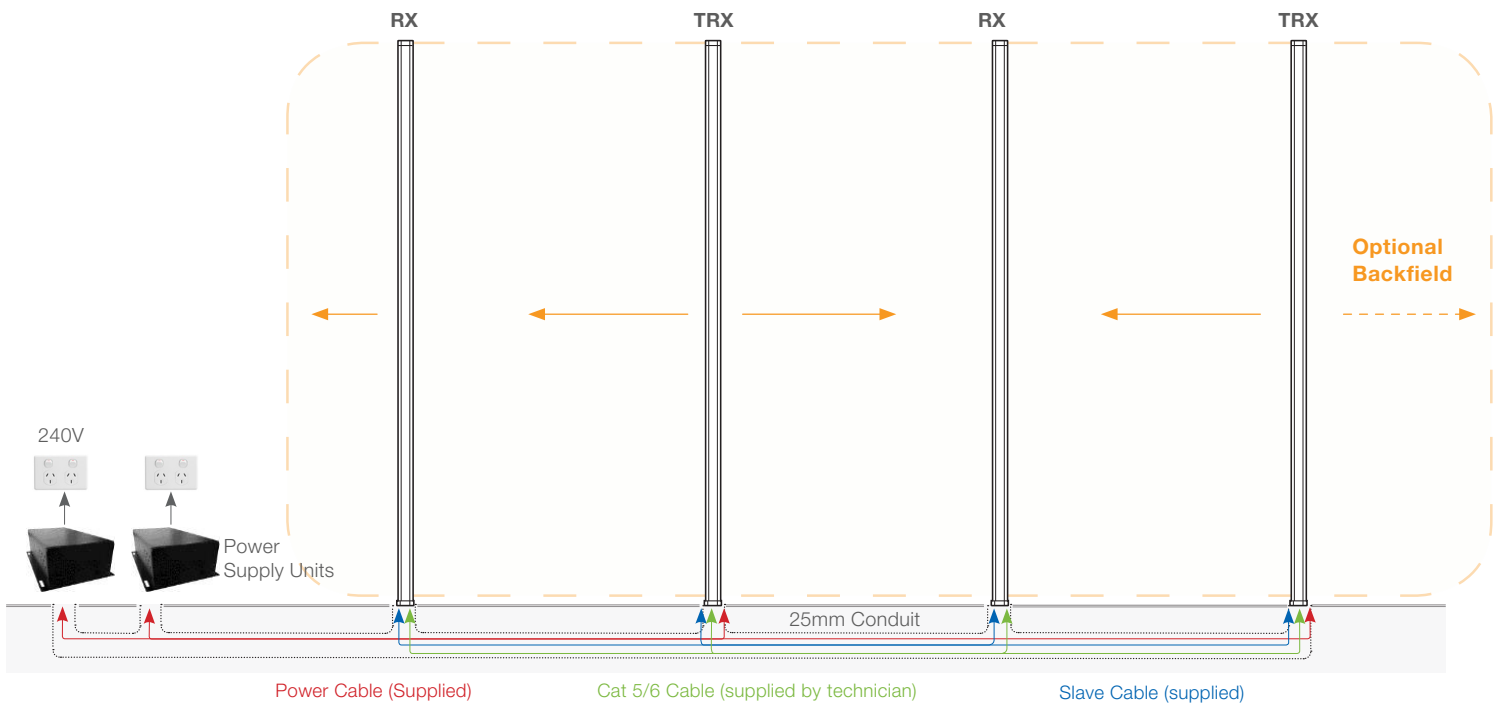

*Additional Pedestals may be added in same configuration

Modus AM30 Nuda transceiver-PSU:

CP2101-6423-5200

Modus AM30 Nuda receiver::

CP2101-6424-5200

Power Supply:

210mm x 172mm x 70mm

Cable Spec

- **Power Cable:** 3 Core 7/0.30 Shielded Control Cable or equivalent.
- **Slave Cable:** Belden-M 8723 Multi-Conductor Shielded Twisted Pair Cable or equivalent.